

# MB126

# LOGIC CONTROL

# LOW VOLTAGE

MADE IN AUSTRALIA

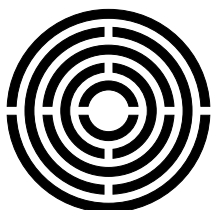
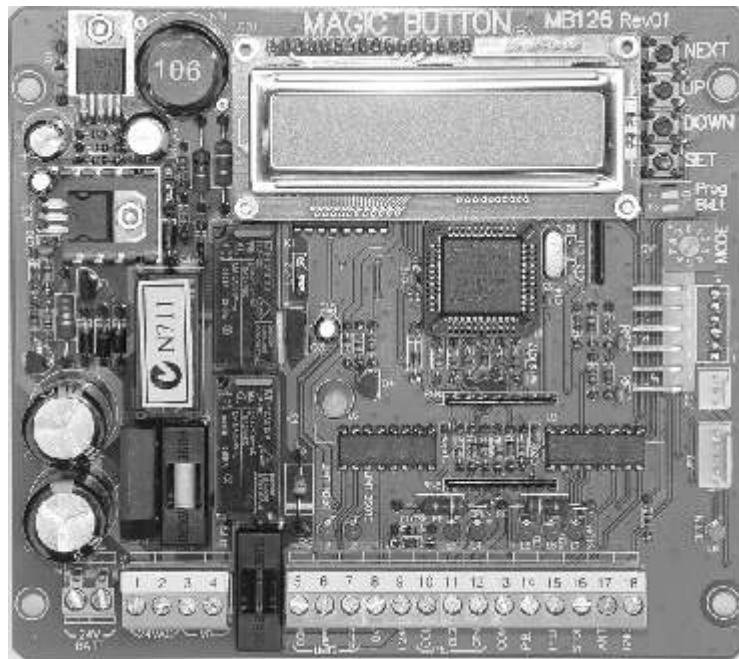

# LIFTMASTER

**Please read these instructions  
carefully before adjusting the  
Liftmaster Magic Button MB126  
control board's default parameter  
settings**

# 1.0 MB126 MAIN FEATURES

- ▶ LCD display with back-light
- ▶ Micro controller design
- ▶ Rotary switch mode selection
- ▶ End of travel slow down with adjustment
- ▶ Motor force control with adjustment
- ▶ Suitable for either 12V or 24V motors
- ▶ Suitable for single motors with or without limits
- ▶ Leaf delay control
- ▶ Inputs for push button and pedestrian
- ▶ Pedestrian access control
- ▶ P.E. 1 (close) inputs & P.E. 2 (open) inputs
- ▶ Output to support relays for lights
- ▶ Output for indication of board status
- ▶ Backup closing timer
- ▶ 6 pin receiver compatible
- ▶ On board antenna input
- ▶ 24V DC power supply protected by 1 amp fuse
- ▶ Optocoupler protection on all inputs
- ▶ LED indicators on all inputs for visual indication on input status
- ▶ Resettable and non-resettable counters
- ▶ Different motor speed selectable
- ▶ Support relay P.E. or pulsing P.E.
- ▶ Current sensor
- ▶ Input for RPM sensor
- ▶ On board 12V or 24V battery charging circuit

**Note:** The availability of some of this control board's features are dependent upon individual applications and motor drive configuration. Qualify feature suitability before use

## **2.0 IMPORTANT SAFETY INSTRUCTIONS**

Please read these important safety rules. Failure to comply with the following safety rules may result in serious personal injury and or property damage.

**2.1** When the MB126 logic control board is used to control gate, door, and barrier gate operating equipment the following factors **MUST** be taken into account:

**A)** Appropriate safety devices relevant to the particular application must be incorporated into the installation of all moving structures

**B)** Safety devices need to be regularly checked for the correct operation

**C)** The gate or door must be able to be freely moved by hand before motorisation

**D)** Warning signs must be visibly installed on either side of the structure

**E)** All programming must be undertaken by qualified technicians

**F)** Any device used to initiate the logic controller must be kept away from children

**G)** Wind loading on the operated structures will unavoidably alter operation functions

**2.2** Do not activate the MB126 logic control board unless the moving structure is in full and clear view and free of objects such as vehicles and people

**2.3** The MB126 logic controller must be connected to properly approved earthed 240V power supply

**2.4** The main power supply must be disconnected before making any repairs

**2.5** Any additional device(s) utilising the MB126 on board DC power supply must not exceed, under load, the total transformer Amp rating

**2.6** Water, dust, and insect presence on the MB126 logic control board must be prevented

**2.7** Do not leave packing materials (plastic, polystyrene, etc.) within reach of children as such materials are potential sources of danger

**2.8** Liftmaster declines all liability caused by improper use or use other than that for which the automated system was intended

**2.9** Do not install the equipment in an explosive atmosphere: the presence of inflammable gas or fumes is a serious danger to safety

**2.10** Liftmaster is not responsible for the failure to observe good technique in the design and construction of the structure(s) to be motorised and or any deformation that may occur during use

**2.11** If parameter P7 (Back Up Timer) is used the door/gate, once the run time is complete or the limits reached, will **automatically close** when the set value of back up time has expired. This closing will occur **without warning, an appropriate safety device must be installed**

**2.12** If parameter P16 and/or P17 is used then some type of mechanical/electronic clutch must be fitted as the motor will not stop at the end of travel time but will continue to run until the selected additional time has expired. This may result in excessive force on the fixtures and fittings depending on the torque on the motor when installed

**2.13** The effectiveness and compatibility of parameter P15 is dependent of the type of motor to be controlled, qualify the suitability of P15 before use

## 3.0 INSTALLATION GUIDELINES

All electrical works must be carried out by a qualified electrical contractor in accordance with local authority regulations. Following is a list of installation guidelines:

**3.1** Motor supply voltage, battery voltage and relay type must be set (Refer to section 4)

**3.2** Input power supply to the transformer is 240V 3 wire (Active, Neutral, and Earth). The input supply must have some means of power isolation.

**3.3** All wiring conduit and cable gland entries to control box should be via the base only.

**3.4** The recommended motor wire size is 1.5mm<sup>2</sup> multistrand. For the control circuits the wire size is 0.5mm<sup>2</sup> stranded. High and low voltage cabling should not be run in the same conduit.

**3.5** All control and limit switch inputs must be DRY switch contacts only. Ensure that all devices being used for gate/door activation have dry contact outputs before connecting to control board. If the device has a voltage output, a relay will be required.

## 4.0 LNK's

**LNK1:** 1+2 = for 24VDC motor (use 24VDC transformer)  
2+3 = for 12VDC motor (use 12VDC transformer)

**LNK2:** 1+2 = for 24V battery backup charging circuit  
2+3 = for 12V battery backup charging circuit

## **5.0 WIRING MOTORS AND ACCESSORIES TO THE CONTROL BOARD**

- 1.** Connect motor to control board. Once motor is connected to control board, manually move gate/door to the mid position and engage the motor.
- 2.** Turn power on to control board and activate motor (using push button or programmed remote etc). Motor should move towards open position. If the gate/door moves towards closed position, switch power OFF and reverse open/close motor wires (and open/close limit wires where used). Turn power ON and re-test for correct motor operating direction.
- 3.** Once correct motor direction is established, the board parameters can be modified to suit the installation, and the mode selected.

## **6.0 STATUS INDICATORS L1 - L8**

- L1** - Motor one open limit input status: normally ON, OFF when open limit activated
- L2** - Motor one close limit input status: normally ON, OFF when close limit activated
- L3** - Safety input close indicator: indicates if safety input obstructed, MUST be OFF for board operation
- L4** - Safety input open indicator: indicates if safety input obstructed, MUST be OFF for board operation
- L5** - ON indicator for PB input
- L6** - ON indicator for PED input
- L7** - ON indicator for STOP input
- L8** - Board status indicator: indicator OFF when the board is idle and the motor is in the CLOSED position. Once PB or PED input made, then indicator remains ON until the cycle CLOSE-OPEN-CLOSE is complete either by limit(s) or when the close travel time setting is expired

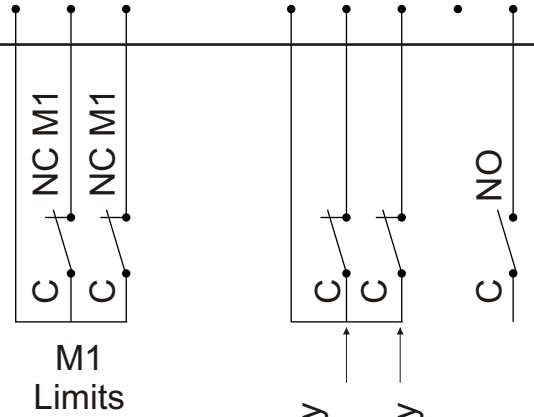
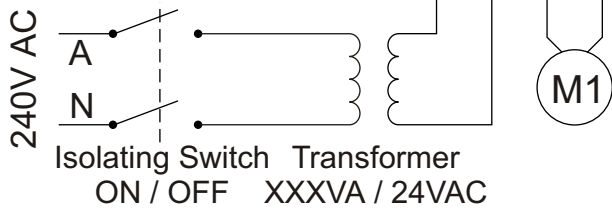
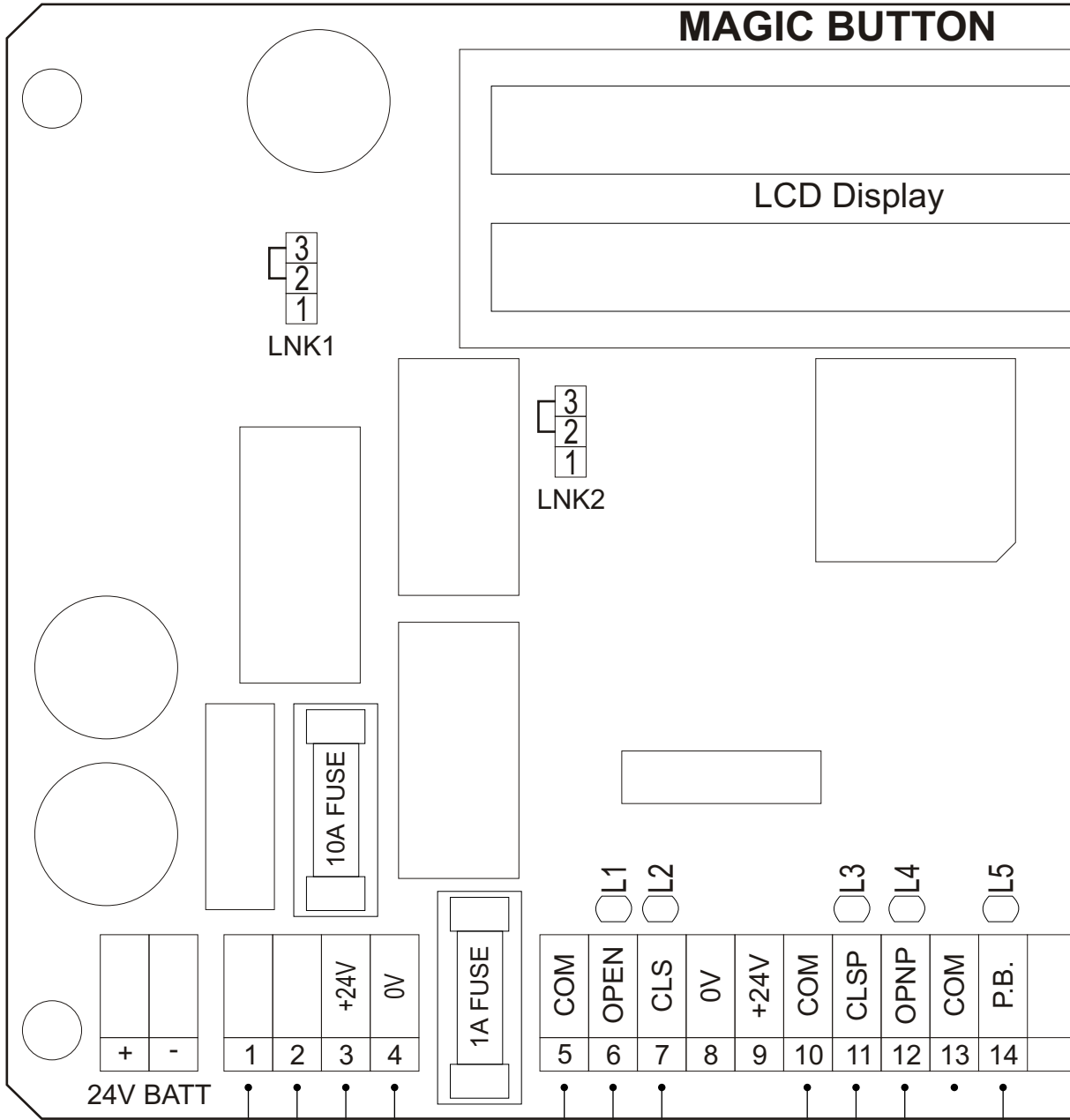



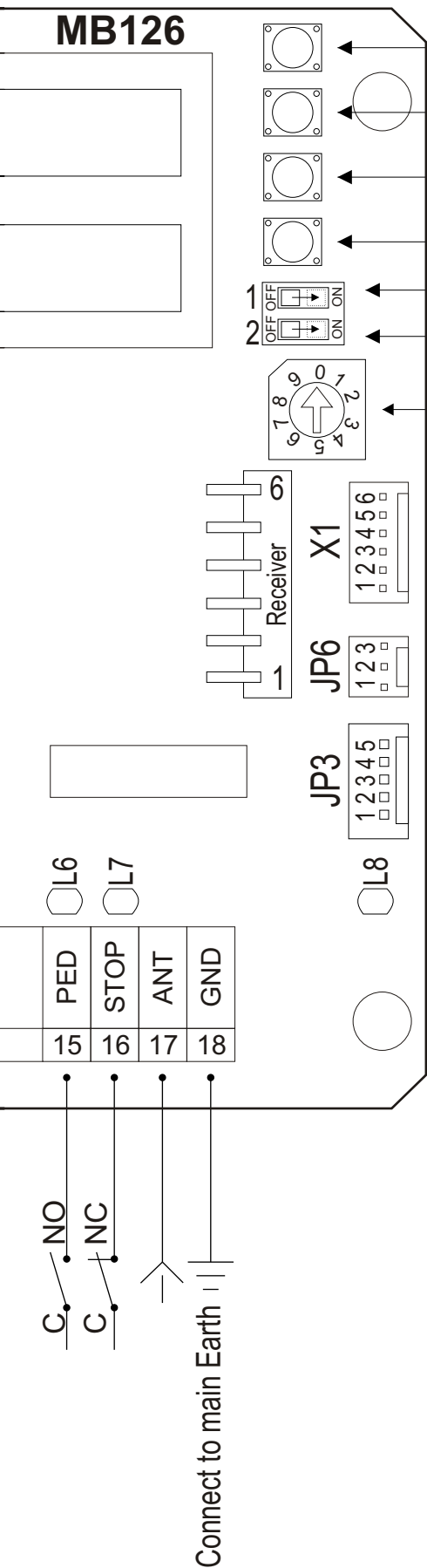

- ← NEXT: Move to the next parameter
- ← UP: Increase the parameter value
- ← DOWN: Decrease the parameter value
- ← SET: Save the parameter value
- ← Program Switch: Enables programming
- ← Back-light Switch: Activates LED display back-light
- ← Mode Selection:
  1. Pulse open / pulse close
  2. Pulse open / auto. close
  3. Pulse open / P.E. close
  4. Counting mode

**Note on Fuses:** before changing the fuse(s), identify the cause of the fault, rectify, and then check board functionality including slow down speeds.

**Note:** +24V power supply is 1A

**MB126 CONTROL BOARD**

**FOR 12V/24V DC 5A MOTORS**

LIFTMASTER ELECTRONICS PTY LTD

Phone: (02) 9699 9654 Fax: (02) 9699 8443

[www.liftmaster.com.au](http://www.liftmaster.com.au)

MB126 - 0407 - REV.01



## 8.0 HOW TO MODIFY THE PARAMETERS

Please note that the board parameters can only be modified while the board is inactive (LED 8 is off) and the door/gate is in the closed position. Factory supplied board is preset to default settings and must be site adjusted.

1. Turn switch No.1 (program switch) ON. To turn the display back-light on, turn switch No.2 ON
2. Display will show the first parameter, P1
3. To change the parameter value press UP or DOWN buttons
4. To save the value, press the SET button
5. To modify the next parameter, press NEXT
6. To exit programming, turn switch No.1 OFF

The following is a list of parameter values that can be modified. 'P' = parameter, 'M' = motor, 'Def' = default, 'Now' = saved parameter value.

MB126 is a universal 12/24V control board, suitable for any applicable motor to 5 Amp. The motor type must be selected in P1. Liftmaster has customised the following motor types to optimise performance.

Type 1 - Liftmaster LYN, SCS & SLY324 motors

Type 2 - Liftmaster ART, SUB & SLY524 motors. FAAC, Genius & ATA motors

Type 3 - Universal type motors to 5 Amp : Contact Liftmaster for further details

DISPLAY ON LCD	COMMENT	RANGE	MY SETTINGS
P1 = Motor Type Def: 0 Now: 0	Select Motor Type, 0 - Board will not operate, 1, 2 or 3 (see page 10)	0 - 3	
P2 = M1 Travel Time Def: 5 Now: 5.0s	Set motor travel time	0 - 99 secs	
P3 = Auto CIs Delay Def: 1 Now: 1.0s	Set hold open time delay before closing	0 - 99 secs	
P4 = M1 Force Adj Def: 50% Now: 50%	Adjust motor force	30 - 100%	
P5 = M1 Slow Down Def: 0 Now: 0.0s	Motor slow down prior to stopping	0 - 10 secs	
P6 = M1 Soft Start Def: 0 Now: 0.0s	Motor soft start	0 - 5 secs	
P7 = Back Up Timer Def: 0 Now: 0.0s	Mode 3 only. Close door/gate if back out occurs & close PE/loop not triggered. WARNING: must use safety devices	0 - 65 secs	
P8 = Open PE Type Def: RLY Now: RLY	Select PE type being used, RLY - Relay PLS - Pulse	RLY - PLS	
P9 = Close PE Type Def: RLY Now: RLY	Select PE type being used, RLY - Relay PLS - Pulse	RLY - PLS	
P10 = PE Reverse Def: Yes Now: Yes	Motor reverses when PE/Loop triggered if motor closing. Next motor direction mode dependent. If set to No motor stops when PE/Loop triggered. Next motor direction mode dependent	No - Yes	
P11 = Opn PE ReOpen Def: No Now: No	During opening cycle & Open PE is broken gate leaf will stop. Once Open PE cleared gate leaf will either re-close = NO or re-open = YES	No - Yes	
P12 = PED Travel Def: 5 Now: 5.0s	Set pedestrian mode travel time	0 - 99 secs	

P13 = PED Auto Close Def: No Now: No	Set pedestrian mode to automatic close	NO - YES Refer P3
P14 = Pwr Fail Close Def: No Now: No	Set to YES gate/door will close automatically after power failure restored. Set to No gate/door will require a pulse to activate	No – Yes
P15 = Motor Speed Def: 10 Now: 10	Motor torque is speed related, as speed is reduced motor torque will be less	1 - 10
P16 = ExtraOpnTime Def: 2 Now: 2.0s	Add additional open time to P1 to compensate for wind loading or mechanical loading	0 –10 secs
P17 = ExtraClisTime Def: 2 Now: 2.0s	Add additional close time to P1 to compensate for wind loading or mechanical loading	0 –10 secs
P18 = Battery Type Def: 24 Now: 24	Back up battery type: 2 x 12V battery for 24V system 1 x 12V battery for 12V system	24V - 12V
P19 = Battery Low Opn Def: No Now: No	NO - gate/door will remain closed when battery is low YES - gate/door will open when battery is low	No – Yes
P20 = RPM Sense Def: No Now: No	Used as back up for safety. Leave as <b>Def: NO</b> if battery backup used	No – Yes
P21 = Total Cycles #Cycles = 0000000	Non resettable cycle counter	Cycle = one complete close - open - close
P22 = Resettable Cycl #Cycles = 000000	Resettable cycle counter	
P23 = Reset Cycles Def: No Now: No	Reset parameter P22	
P24 = Reset Default Def: No Now: No	Reset all parameters P1 to P23 to the default values (excluding P21)	
P25 = Software Rev Revision 1.0	Software version	

## 9.0 JP3 OUTPUT OPTION

The use of JP3 requires an optional plug

JP3 output is compatible with all previous Liftmaster IK series control boards. JP3 can be used to start a timer (for example - on garden lights) or a relay kit could be plugged into it and used to control warning lights.

□ 1	← AUX open signal	— Pin1 output is ON during opening cycle
□ 2	← AUX close signal	— Pin2 output is ON during closing cycle
□ 3	← +12V	— Pin3 is +12V can be used to supply accessory max, 100mA
□ 4	← Common AUX signal	— Pin4 is <b>0V</b> output
□ 5	← Board status output	— Pin5 is the board status output, ON when the board is active

\* Option 1 is the default setting on the MB206

## 10.0 JP6 RPM SENSOR

JP6 is the input for motor RPM sensor. RPM Sensor is used for extra safety. If used P19 needs to be changed to YES.

## 11.0 PULSING FAIL SAFE PHOTO ELECTRIC

Pulsing fail safe photo electric is a two-wire system, and PE does NOT have a relay output. To use pulsing fail safe photo electric change P8 and/or P9 to PLS in menu.

Wiring Diagram for Pulsing Fail Safe Photocell

**Safety on Closing Set (Reverse)**

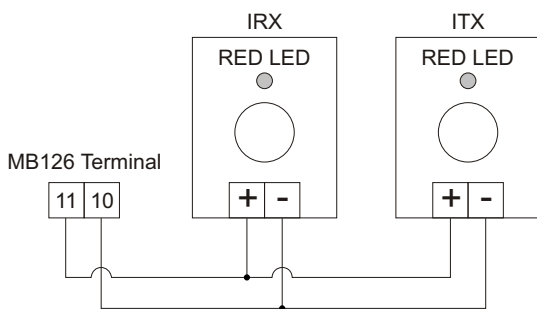

Red LED constant ON = PE aligned  
Red LED flashing = PE unaligned

**Safety on Opening Set (Stop)**

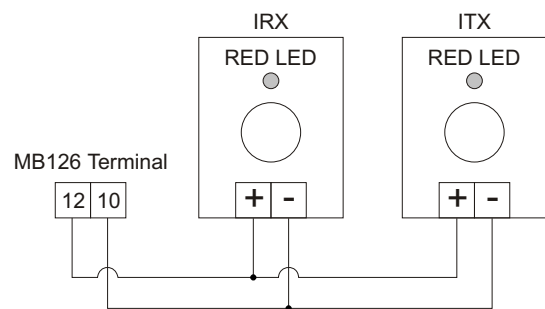

Red LED constant ON = PE aligned  
Red LED flashing = PE unaligned

# NOTES

A series of horizontal dotted lines for writing notes.

# OTHER LIFTMASTER PRODUCTS

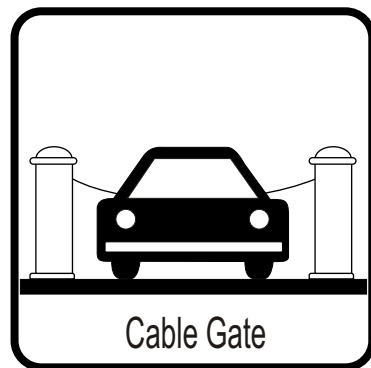
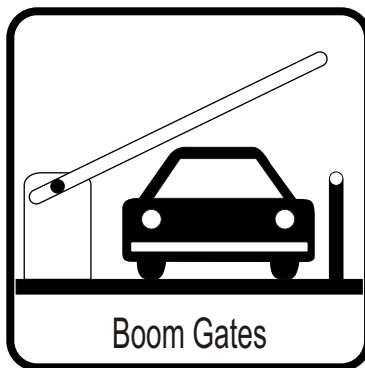
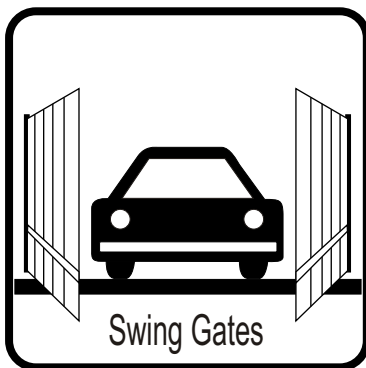
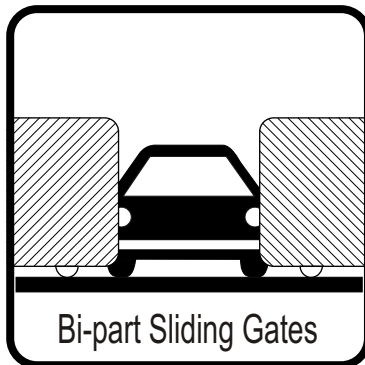
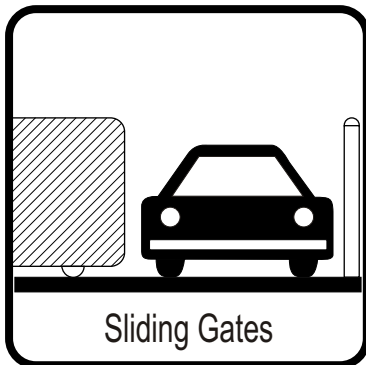
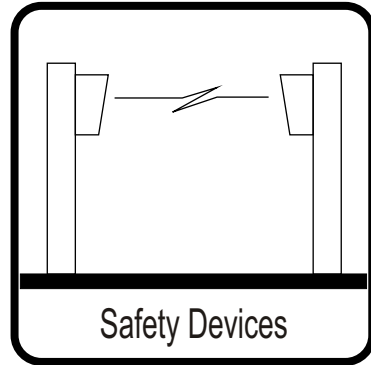
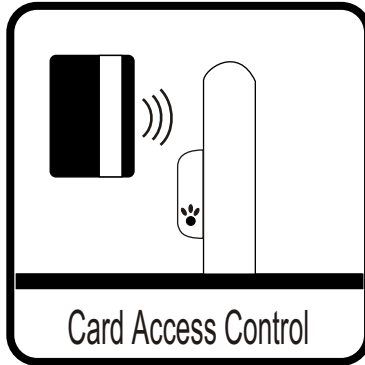
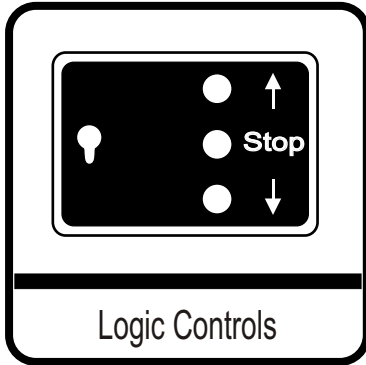

**DOMESTIC • COMMERCIAL • INDUSTRIAL**

**LIFTMASTER ELECTRONICS PTY LTD A.B.N. 58 000 266 035**

PO BOX 54 ALEXANDRIA NSW 1435 AUSTRALIA

PH: 61 2 9699 9654 FX: 61 2 9699 8443

[www.liftmaster.com.au](http://www.liftmaster.com.au) [salesdesk@liftmaster.com.au](mailto:salesdesk@liftmaster.com.au)

As Liftmaster Electronics policy is one of constant improvement, we reserve the right to alter any part of these specifications without notice and without incurring any obligation.